

REV
NC DT06-12S*

REVISIONS			
SYM	DESCRIPTION	DATE	APPROVED
NC	REVISED AND REPLACES PREVIOUS		
	RELEASE PER E.O. P18204	6-27-03	RDR

DATE CODE: MONTH REPRESENTED BY SEQUENTIAL ALPHA CHARACTERS.
EX. A = JANUARY

DATE CODE: YEAR IS REPRESENTED BY LAST NUMERICAL DIGIT.
EX. 6 = 2006

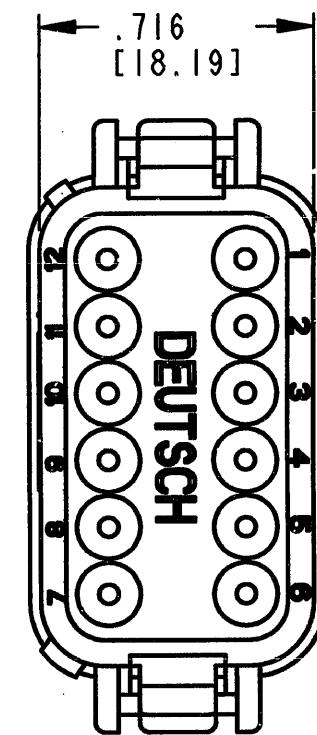
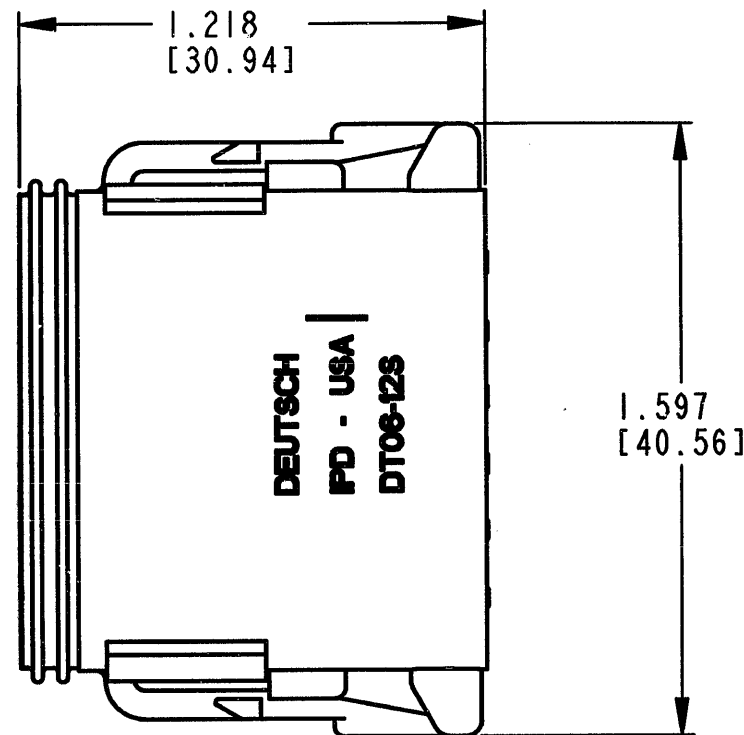
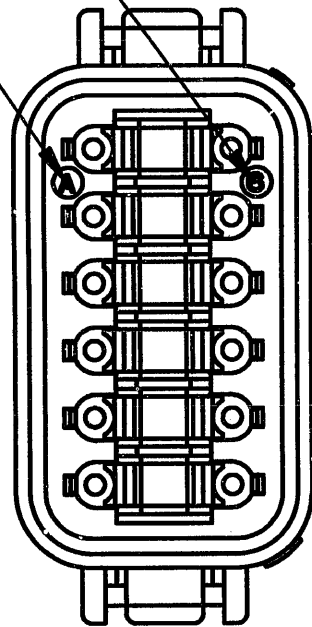

CONTACT SIZE	MIN. INSUL O.D.	MAX. INSUL O.D.	WIRE RANGE [mm ²] REF. ONLY ³
16	.088 [2.24]	.145 [3.68]	14-20 AWG [2.0-0.5]

- 5. MATERIAL: SHELL:PLASTIC; GROMMET: RUBBER.
- 4. THIS PLUG MATES WITH DT04-12P*-**** RECEPTACLE.
(* = A,B,C,D KEY ARRANGEMENT; **** = ALL MODIFICATIONS).
CONSULT FACTORY FOR ALL MODIFICATIONS.

³ FOR CONTACTS AND WIRE PERFORMANCE AND APPLICATION CHARACTERSTICS, SEE ENVELOPE DRAWING 0425-015-0000 AND 0425-017-0000.

- 2. DIMENSIONS ARE ±.025[.64] UNLESS OTHERWISE SPECIFIED.
- 1. ALL DIMENSIONS ARE INCHES (MILLIMETERS).

NOTES:

SIGNATURE & DATE	
DR	TYOHANNES 06JUN03
CHK	<i>A. Polinski</i> 6/24/03
PE	<i>John Polinski</i> 6/20/07
APPD	<i>SBend</i> 623-03
SCALE	NONE WT _____

12 WAY PLUG
DT SERIES

ENVELOPE

CP	MATL. CODE
The Deutch Company  DEUTSCH I.P.D. 3850 INDUSTRIAL AVE. HEMET, CALIF. 92545	
B	DT06-12S*
DWG SIZE	SHEET 1 OF 2

REV NC	DT06-12S*	REVISIONS			
		SYM	DESCRIPTION	DATE	APPROVED
			SEE SHEET ONE	6-27-03	RDR

PART NO: DT06-12SA
KEY ARR. -A-
COLOR: GRAY

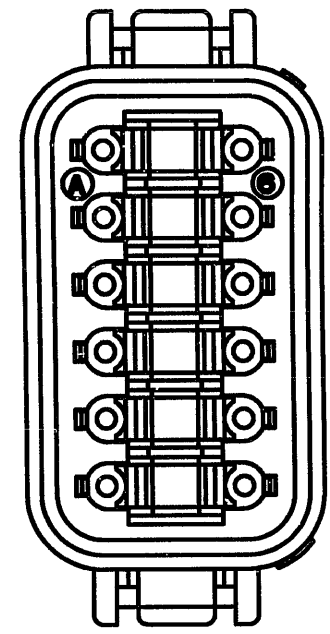

PART NO: DT06-12SB
KEY ARR. -B-
COLOR: BLACK

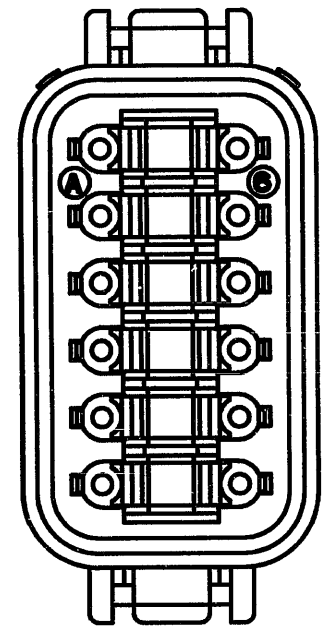

PART NO: DT06-12SC
KEY ARR. -C-
COLOR: GREEN

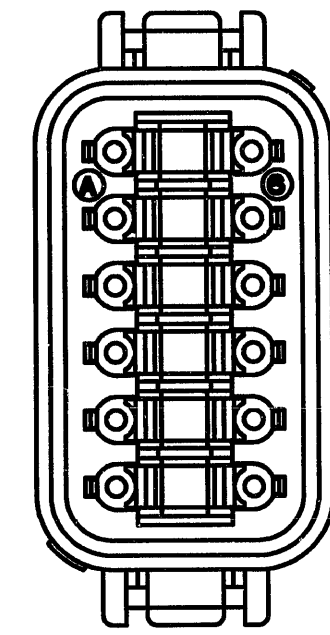

PART NO: DT06-12SD
KEY ARR. -D-
COLOR: BROWN

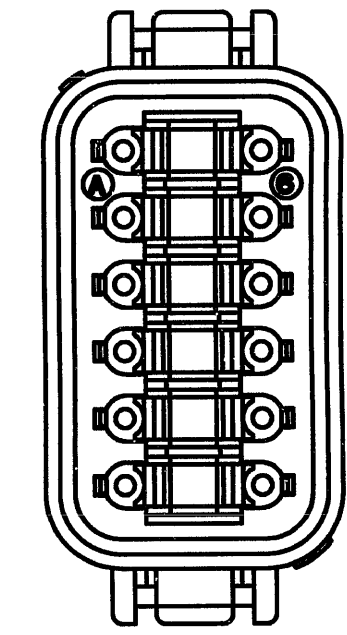

NOTES: SEE SHEET ONE.

SIGNATURE & DATE		12 WAY PLUG DT SERIES ENVELOPE	CP	MATL. CODE	
DR	TYOHANNES 06JUN03		The Deutch Company DEUTSCH I.P.D. 3850 INDUSTRIAL AVE. HEMET, CALIF. 92545		
CHK	<i>R. Polinski</i> 6/24/03		B DT06-12S*	CODE	SHEET 2 OF 2
PE	<i>Teja Golan</i> 6/20/07			DWG SIZE	11139
APPD	<i>EBund</i> 6-23-03		SCALE	NONE	WT